

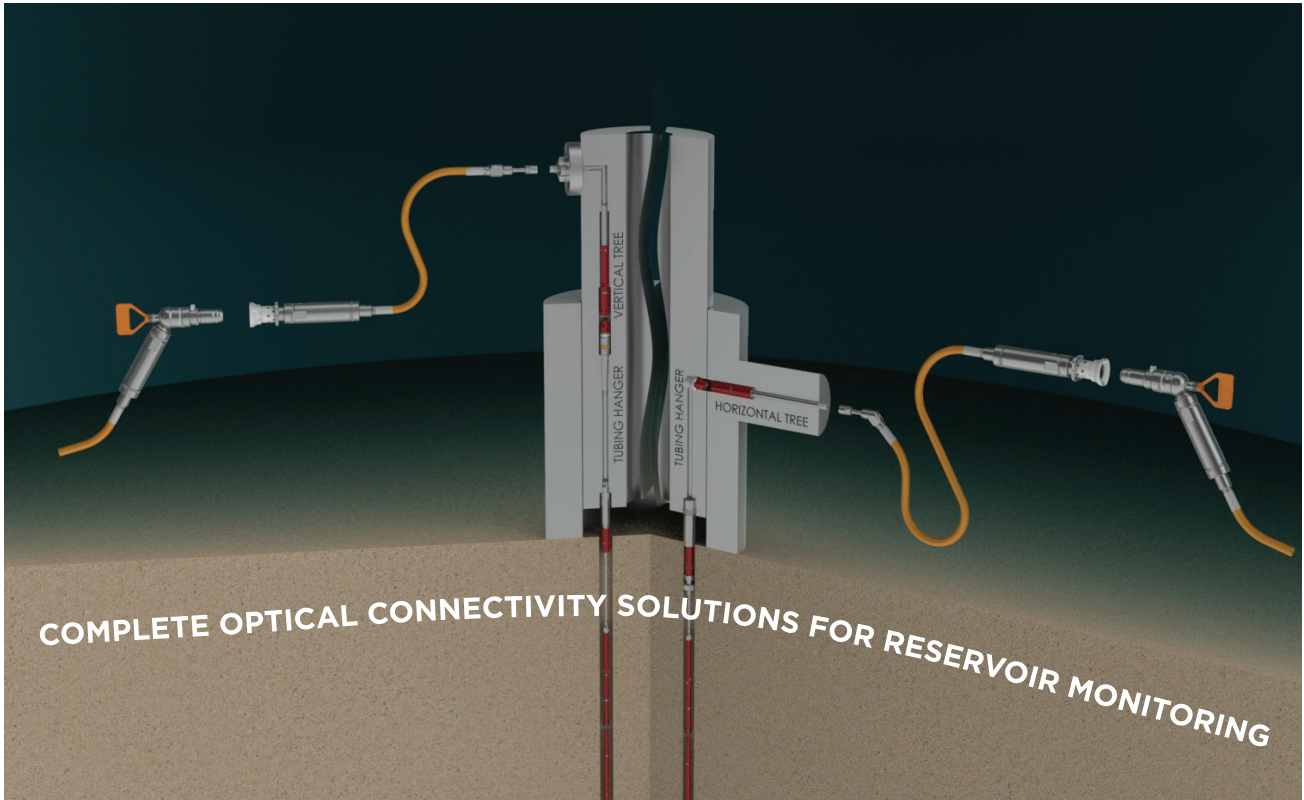

Offshore Fiber-Optic Connectors from Topside to Downhole

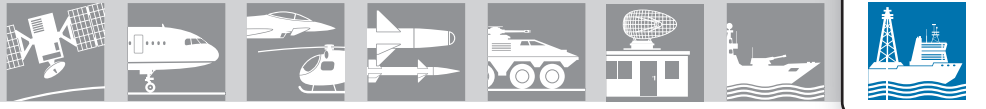

DEUTSCH



Contents

Introduction: Withstand the Hazards of Offshore	3
9316 Series Dry-Mate Connectors	4
Showet Series Hybrid Splash-Zone Connectors	5
MOD Series Splash-Zone Connectors	6
DO3000 Series Wet-Mate Connectors	7
OFS Series Wet-Mate Connectors	8
O-IDH Series Wet-Mate Connectors	9
Comprehensive Offshore Connectivity: Power and Signal	10

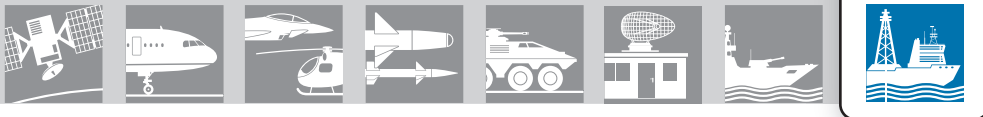

Withstand the Hazards of Offshore

DEUTSCH fiber-optic connectors from TE Connectivity (TE) bring the advantages of high bandwidth, long transmission distances, and small size to offshore applications. Building on our expertise in designing robust, reliable connector systems to meet the challenging and harsh environments of topside, subsea, and downhole environments, we work closely with both equipment designers and exploration/production companies to create connectivity solutions to meet the specific demands of an application.

Among the advantages you will find in our fiber-optic range are the following:

Achieve Longer Distances at Higher Speeds

- Single-mode and multimode fibers, mixable in the same connector
- Excellent optical performance
- Up to 12 optical channels

Find the Right Connector for Your Application

- Dry-mate, splash-zone, and wet-mate configurations
- Explosion-proof versions meeting ATEX/CSA requirements for increased topside safety
- Robust performance under extreme pressures, temperatures, and corrosive conditions

Combine Signals and Controls in a Single Connector

- Hybrid fiber/copper versions with both optical and electrical contacts
- Four multimode fiber lines + four 20 A copper lines

TE Components . . . TE Technology . . . TE Know-how . . .

AMP | Agastat | CII | Hartman | Kilovac | Microdot | Nanonics | Raychem | Rochester | DEUTSCH

Get your product to market faster with a smarter, better solution.

Go to: DesignSmarterFaster.com.
Your best place to get started, today!

Here you can get connected to the inner circle of TE AD&M's best thinkers. Working together early in your design review process, we can help you reach a better connectivity solution.

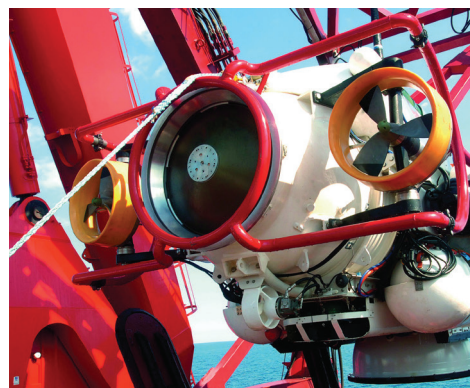
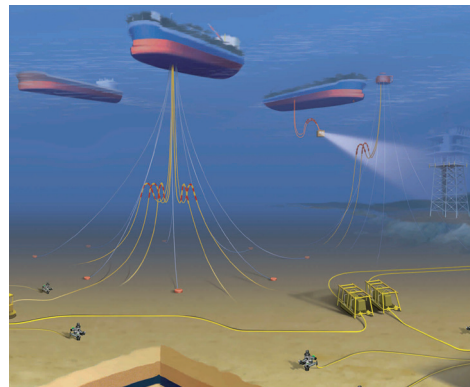

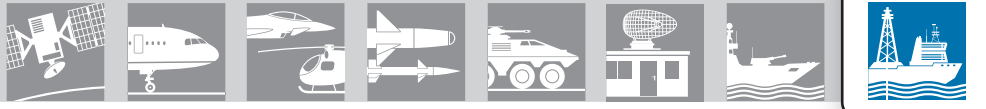

9316 Series Dry-Mate Connectors

Designed for easy handling and to withstand high mechanical stress

- Explosion-proof for use in hazardous areas and polluted environments
- Two shell sizes for 3 or 12 contacts
- Optical and hybrid versions available
- Custom backshell designs available

Applications

Platform
FPSO (Floating Production Storage and Offloading units)
Topside communication

Optical

- **Fiber Type:** Multimode or single mode
- **Insertion Loss:** ≤ 1 dB (0.5 dB typical)
- **Back Reflection (Single Mode):** -40 dB

Electrical

- **Service Voltage:**
Service 1: 250 VAC
Service 2: 650 VAC
- **Withstanding Voltage:**
Service 1: 1500 VAC
Service 2: 2300 VAC
- **Insulation Resistance:** >5000 M Ω at 25°C and 65% relative humidity
- **Current Rating:** 17 A per contact

Materials/Performance

- **Shell Material:** Stainless steel
AISI 316 L passivated
- **Operating Temperature:** -55°C to 85°C (-67°F to 185°F)
- **Pressure:** Up to 150 bars (2175 psi) (depending on cable termination)
- **Durability:** 500 mating cycles

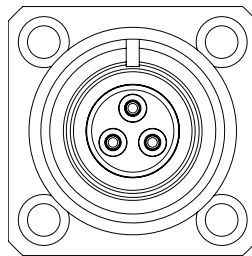

12-93
3 Contacts, Size 12
Service 2

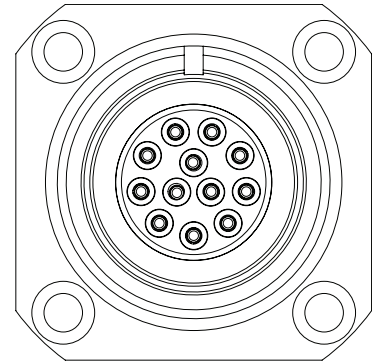

37-3
12 Contacts, Size 12
Service 1

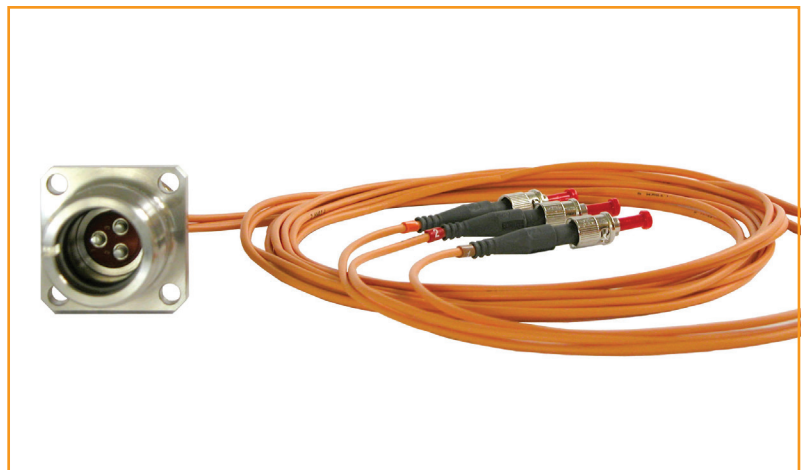

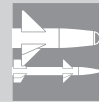

Showet Series Hybrid Splash-Zone Connectors

Support both copper and fiber in a single shell for signal and control needs

- 4 multimode optical and
4 copper contacts

Applications

Topside communications
Sonar systems

Optical

- **Contacts:** 4 multimode optical lines
- **Insertion Loss:** ≤ 1 dB (0.5 dB typical)
- **Back Reflection:** ≤ -40 dB

Electrical

- **Contacts:** 4 (Size 12)
- **Voltage Rating:** 600 VAC
- **Current Rating:** 20 A per contact

Materials

- **Main Body:** Stainless steel AISI 316 L passivated (Other materials on request)
- **Coupling Ring:** Marine bronze
- **Electrical Contacts:** Gold-plated copper

Environmental

- **Rated Pressure:** 80 bars (1160 psi)
- **Pressure Test:** 120 bars (1740 psi)
- **Rated Temperature:** 5°C to 45°C (41°F to 113°F)



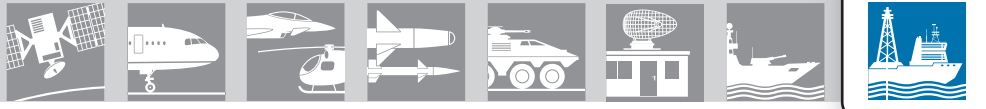

MOD Series Splash-Zone Connectors

Quick connect/disconnect in hazardous areas such as FPSO turrets

- Explosion-proof
- Up to 8 fibers

Applications

- FPSO turrets

Optical

- **Contacts:** up to 8
- **Insertion Loss:** ≤ 0.5 dB typical
 ≤ 1 dB max.
- **Back Reflection:**
Single Mode: ≤ -40 dB
Multimode: ≤ -35 dB

Environmental

- **Rated Pressure:**
Receptacle: 40 bars (580 psi)
Plug: 5 bars (72 psi)
- **Operational Temperature:** 0 to 60°C
(32°F to 140°F)
- **Storage Temperature:** -20 to 50°C
(-4°F to 122°F)
- **Hazardous Environments:** Connector and backshell comply with IEC 60079-28 and IEC 60079-0/II G Ex op pr II T6 (if operating temperature $< 45^\circ\text{C}$)

Materials

- **Shells:** Stainless steel
AISI 316 L passivated
- **Retaining Nuts:** Marine bronze
- **Insulators:** PEEK
- **Optical Contacts:** Stainless steel with ceramic ferrule and sleeve

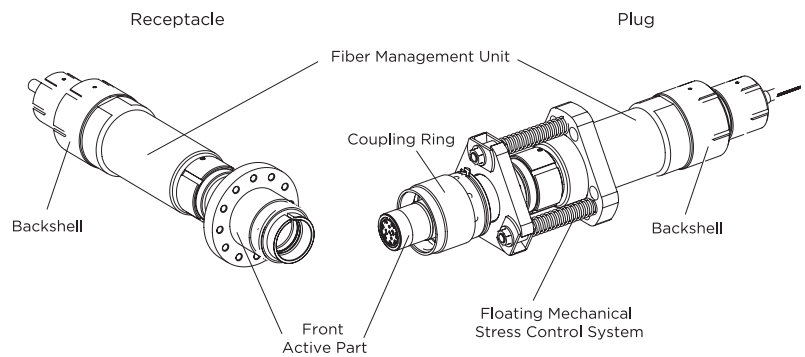
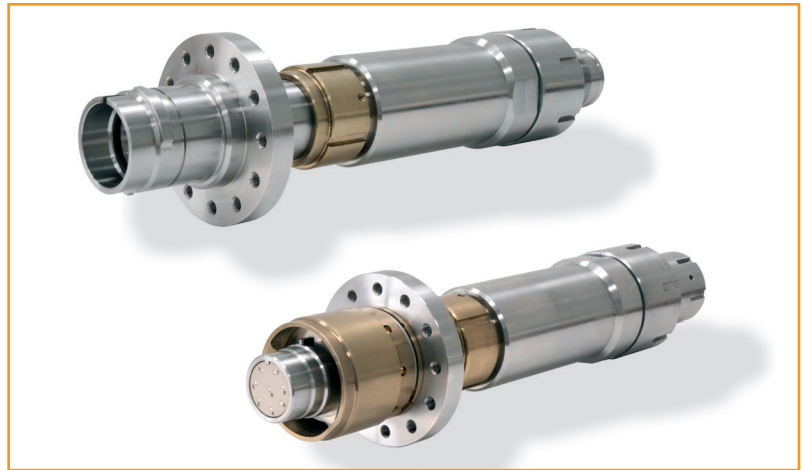

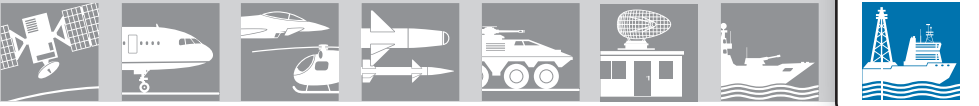

DO3000 Series Wet-Mate Connectors

Optimized for subsea distribution systems and connections to subsea trees

- Up to 12 fibers
- ROV, bulkhead, stab plate, and diver versions
- Operational seawater depths to 4500 meters

Applications

- ROVs
- Subsea distribution systems
- Vertical trees
- Horizontal trees

Optical

- **Contacts:** up to 12 single mode or multimode
- **Insertion Loss:** ≤ 0.5 dB
- **Back Reflection:** ≤ -45 dB
- **Mating Cycles:** 100 min (before gel refill)

Environmental

- **Rated Pressure:** 455 bars (6600 psi)
- **Test Pressure:** 680 bars (9900 psi)
- **Rated Temperature:** -20°C to 50°C (-4°F to 122°F)
- **Storage Temperature:** -40°C to 70°C (-40°F to 158°F)

Materials

- **Connector Body:**
Super Duplex for ROV
Stainless steel AISI 316 L passivated for diver and stab plate

ROV Mating Requirement

- **Mating Force:** <750 N (168 lb.)
- **Demating Force:** >200 N (44 lb.)
- **Maximum Radial Misalignment:** 12 mm (0.47 inch)
- **Maximum Angular Misalignment:** $\pm 20^\circ$
- **Maximum Rotational Misalignment:** $\pm 15^\circ$

Standards/Specifications

- **TOTAL:** GS EP SPS 021
- **STATOIL:** TR1233 final version 2

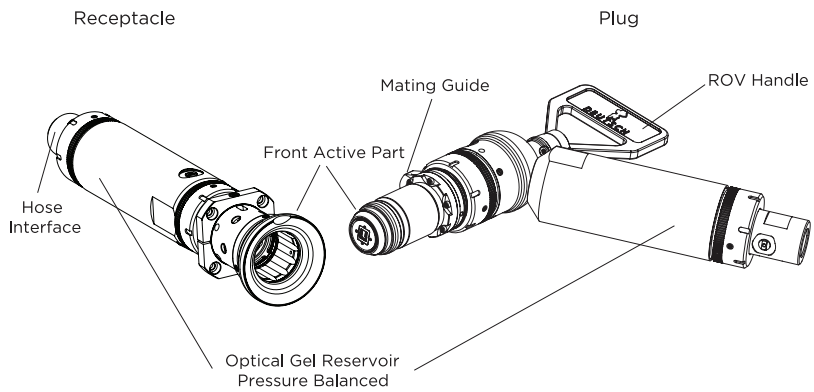

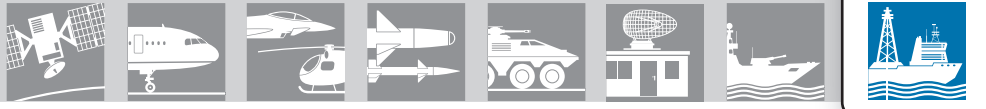

OFS Series Wet-Mate Connectors

Rugged reliability for horizontal or vertical subsea trees

- Optical connectivity between permanently installed downhole sensors/instrumentation and a data acquisition system
- Provide pressure barrier between wellbore and the subsea environment

Applications

- Reservoir permanent monitoring
- Downhole temperature sensing

Optical

- **Contacts:** Customer defined
- **Fiber:** Single mode or multimode
- **Insertion Loss Optical Feedthrough System:**
 ≤ 1.5 dB at ambient conditions
 ≤ 3.5 dB at working conditions
- **Back Reflection:**
 Unkeyed: < -35 dB
 Keyed: < -45 dB
- **Insertion Loss per Connector Pair:**
 < 0.5 dB at ambient conditions
 < 1.5 dB at working conditions

Maximum Working Conditions

- **Number of Wet Matings Before Optical Gel Refilling:** Defined by customer interface

In high pressure areas:

- **Operational Pressure:** 1034 bars (15,000 psi)
- **Test Pressure:** 1551 bars (22,500 psi)
- **Temperature Range:** -20°C to 177°C
 $(-4^{\circ}\text{F}$ to $350^{\circ}\text{F})$

In low pressure areas:

- **Operational Pressure:** 303 bars (4400 psi)
- **Test Pressure:** 455 bars (6600 psi)
- **Temperature Range:** -5°C to 40°C
 $(23^{\circ}\text{F}$ to $104^{\circ}\text{F})$

Operational Environment

- **Primary Sealing:** Metal-to-metal sealing
- **Secondary Sealing:** Elastomeric sealing
 In high pressure area, optical line is glass-to-metal sealed

Standards/Specification

SEAFOM TQP-01, Feb. 2011

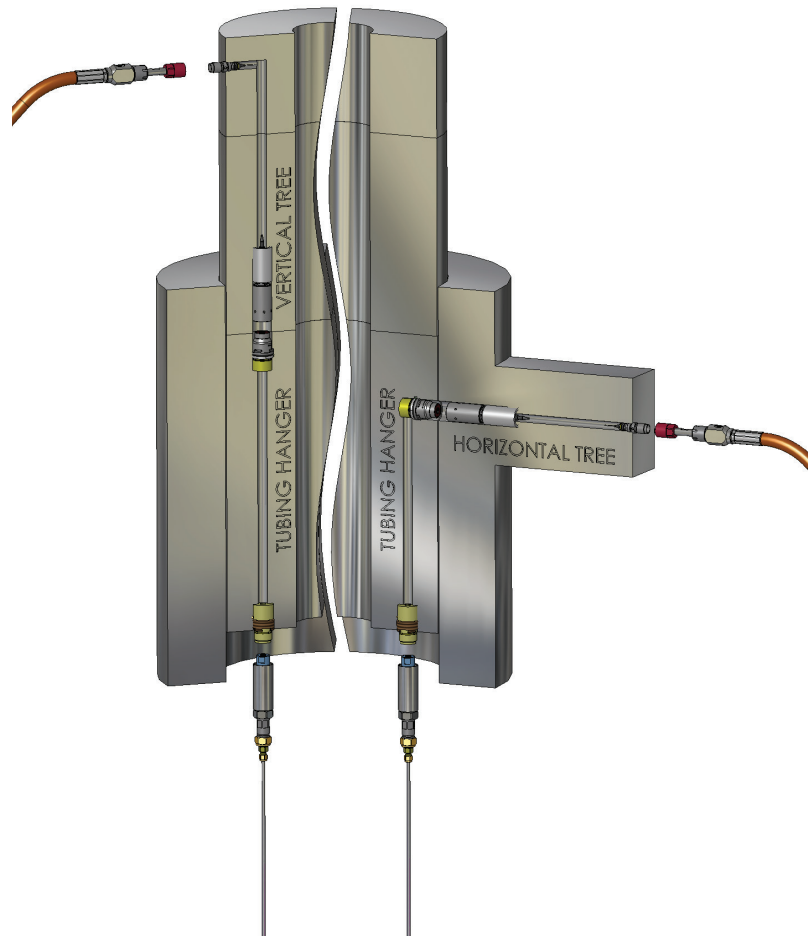

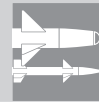

O-1DH Series Wet-Mate Connectors

Optical connectivity for high-pressure, high-temperature downhole applications

- Fit into in-well tight casings
- Optical connectivity from in-well measurement systems

Applications

- In-well measurement systems
- Pressure/temperature gauges
- Flowmeters
- Distributed sensing

Optical

- **Contacts:** 1
- **Insertion Loss, Single Mode and Multimode:**
 - <0.5 dB at ambient conditions
 - <1.5 dB at working conditions
- **Back Reflection:**
 - <-35 dB (multimode)
 - <-40 dB (single mode)
 - <-45 dB with orientation key (single mode and multimode)

Maximum Working Conditions

- **Number of Wet Matings Before Optical Gel Refilling:** Defined by customer interface
- **Rated Pressure:** 1034 bars (15,000 psi)
- **Test Pressure:** 1551 bars (22,500 psi)
- **Working Temperature:** up to 177°C (350°F)
- **Storage Temperature:** -40°C to 70° (-40°F to 158°F)

Materials

- **Connector Body:** Inconel / Superduplex



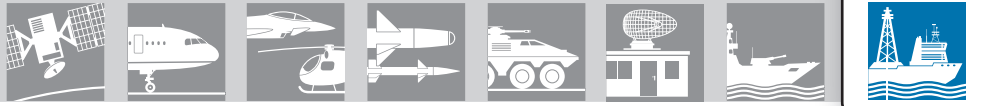

Comprehensive Offshore Connectivity

Beyond optical connectors, we offer a full range of connectors to satisfy your power, signal, and control needs.

Power Connectors

Complete systems, including penetrators, wet-mate connectors, jumpers, etc.

P6-MD300 Quick-Connect/Disconnect Connectors

Explosion-proof for splash zone turret applications

P6-SW1600 Wet-Mate Connection System

6/10 (12) kV, 1600 A, 200 Hz

P18-SW900 Wet-Mate Connection System

18/30 (36) kV, 900 A

P6-3W250 Wet-Mate Connection System

6/10 (12) kV, 250 A

P6-SW400 Wet-Mate Connection System

6/10 (12) kV, 400 A

P18-SW400 Wet-Mate Connection System

18/30 (36) kV, 400 A

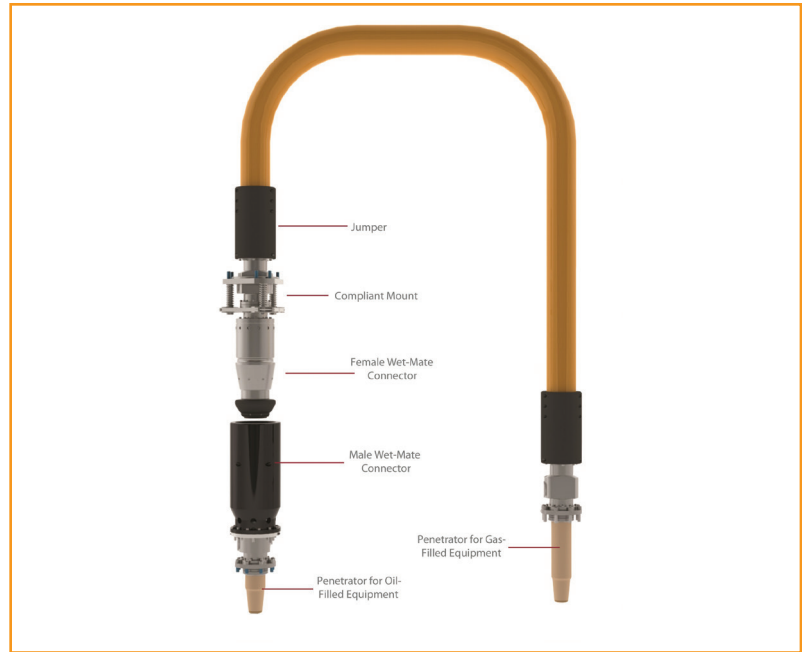

Signal Connectors

Dry-mate, splash-zone, and wet-mate configurations

9316 Series Dry-Mate Connectors

Designed for easy handling and to withstand high mechanical stress

MSD Series Splash-Zone-Mate Connectors

Quick connect/disconnect in hazardous areas such as FPSO turrets

DS3001 Series Wet-Mate Connectors

Optimized for subsea distribution systems and connections to subsea trees

EFS Series Wet- and Dry-Mate Connectors

Electrical feedthrough system for 1140 bar (16,530 psi) rated X-mas trees

DLS Series Wet-Mate Connectors

Compact in-line connectivity for high-pressure, high-temperature downhole applications



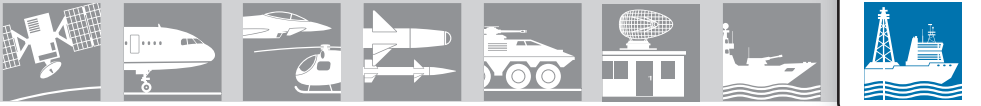

Notes



2 Lydiard Fields, Swindon Wiltshire, SN5 8UB, United Kingdom
Tel: +44(0) 1793 616700 • Fax: +44(0)1793 644304
uksales@is-rayfast.com • www.is-rayfast.com



DEUTSCH